



# GAZİ ÜNİVERSİTESİ TÜRK KIZILAY ÜRÜN ÇALIŞTAYI

---

TEMMUZ /2019

PROJE SUNUMLARI

# 1. GENEL MAKSAT ÇADIRI/ BARINMA ÇADIRI



TÜRK KIZILAY ÜRÜN TASARIM ÇALIŞTAYI 2019



## BARINMA/GENEL MAKSAT ÇADIRI

ÇADIR İÇ DETAYLAR

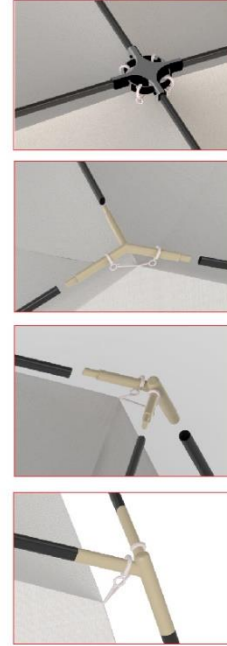

BÜYÜYEBİLEN MODÜLER GENEL MAKSAT ÇADIRLARI



## 2.1. BATTANİYE/ YATAK



TÜRK KIZILAY ÜRÜN TASARIM ÇALIŞTAYI 2019



MATLI YATAK KONSEPT



Yastık

Sünger

Mat

İzolasyon Yüzeyi

Yere Sabitleme Kulbu



EKİP 2/A: BUSE DOLMACI, SELMAN EYİCAN, EMİNE ALPŞAR

**Termobond Elyaflar;**  
sıcaklığı muhafaza etme,  
yüksek hava geçirgenliği,  
koku ve nem tutmama gibi  
özelliklerin yanı sıra  
alerji yapmama özelliğine sahiptir  
Alev geciktirici özelliğe sahiptir.  
Minimum ağırlık 150gr



## 2.2. BATTANİYE/ YATAK



MUTFAK KİTİ



EKİP 2 : SILANUR KENGER , FULYA ÜSTÜNEL , ELİF ALTUN , MERVE KAPLAN



MUTFAK KİTİ



MUTFAK KİTİ

SİLİKON NİHALEYE SAHİP SOFRA BEZİ

BARDAKLARIN VE TUZLUKLARIN İSTİFLENMESİ

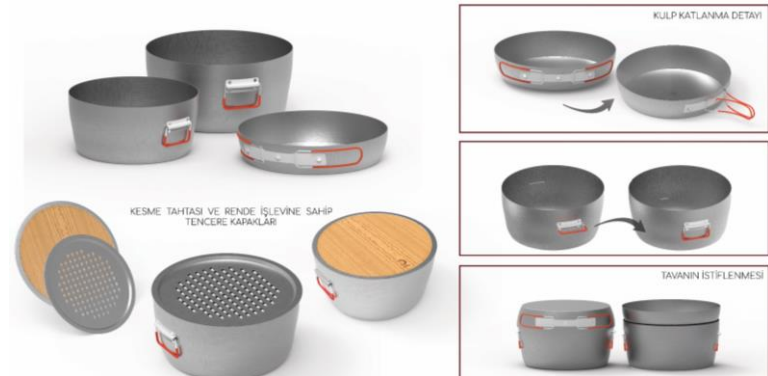

KULP KATLANMA DETAYI

KESME TAHTASI VE RENDE İŞLEVİNE SAHİP TENCERE KAPAKLARI

TAVANIN İSTİFLENMESİ



# 3.1. KONTEYNER YATAKHANE



TÜRK KIZILAY ÜRÜN TASARIM ÇALIŞTAYI 2019



KONTEYNER YATAKHANE

SENARYO 1  
8 - 8

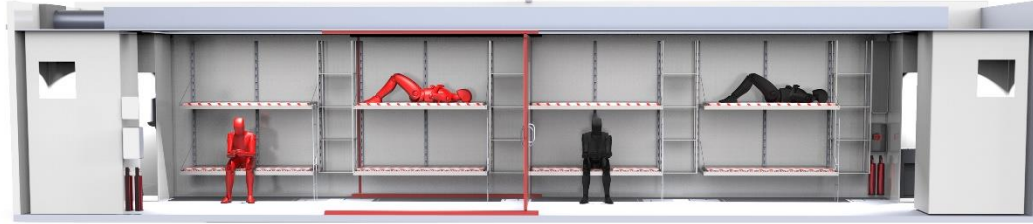

SENARYO 2  
4 - 12



SENARYO 3  
8 - 0

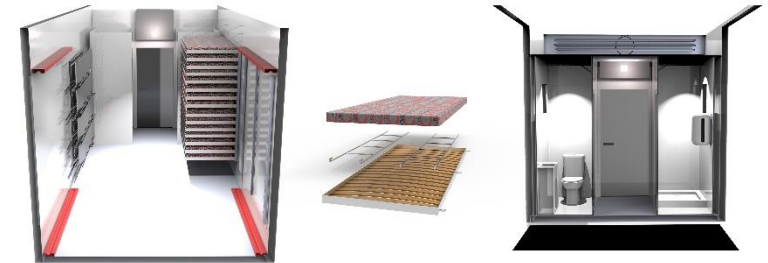
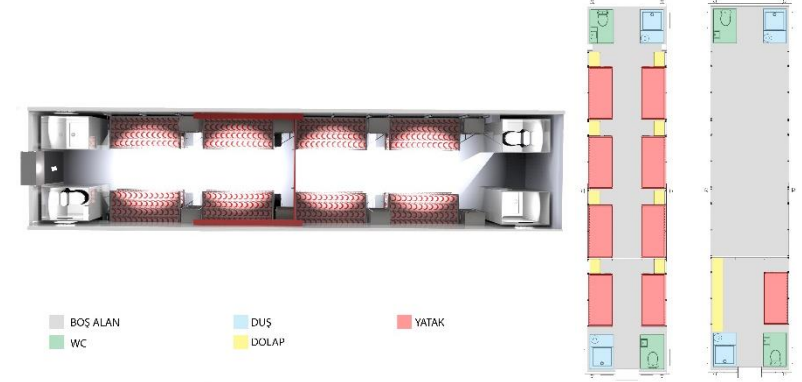
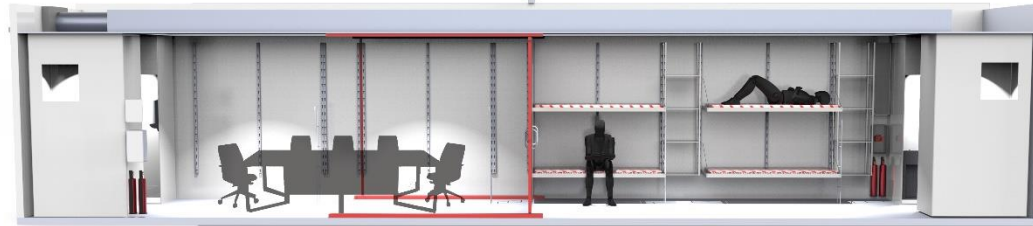

## 3.2. BATTANİYE/ YATAK



TÜRK KIZILAY ÜRÜN TASARIM ÇALIŞTAYI 2019



KONTEYNER OFIS SİSTEMLERİ



EKİP 3/A: İSMAİL DENİZ, MÜNEVVER ASLAN, SENA AHSEN AMIRSHOEV, ŞEYMA GÜRAN



# 4. BATTANİYE/ YATAK



TÜRK KIZILAY ÜRÜN TASARIM ÇALIŞTAYI 2019



MOBİL MUTFAK

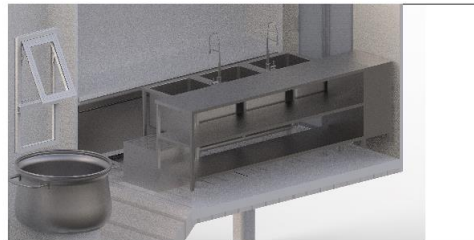
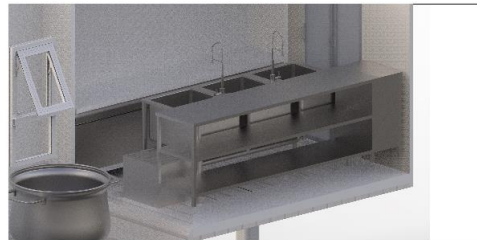

EKİP 4: ELİF YAYLA, FATİH ERTEKİN , HÜSRA ŞAHİN, HAZAL DOĞUKAN, MERVENUR AKASLAN, ORHAN MERT KIRBAŞ, RECEP TEKELİ, YAĞMUR DOĞAN



TÜRK KIZILAY ÜRÜN TASARIM ÇALIŞTAYI 2019



MOBİL MUTFAK

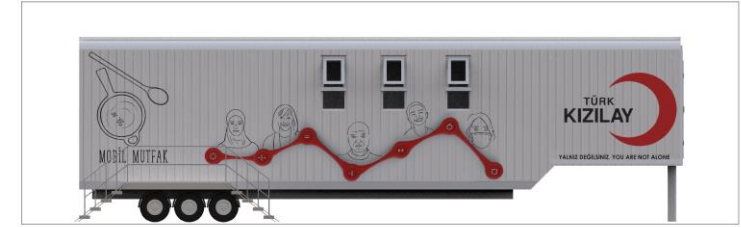

Mobil mutfak projesi varolan mobil mutfak üzerinde, mutfak içindeki iş akışını gözetenek birimlerin düzenlenmesini ve iyileştirilmesini amaçlayan bir sistem tasarımı projesidir.



EKİP 4: ELİF YAYLA, FATİH ERTEKİN , HÜSRA ŞAHİN, HAZAL DOĞUKAN, MERVENUR AKASLAN, ORHAN MERT KIRBAŞ, RECEP TEKELİ, YAĞMUR DOĞAN



TÜRK KIZILAY ÜRÜN TASARIM ÇALIŞTAYI 2019

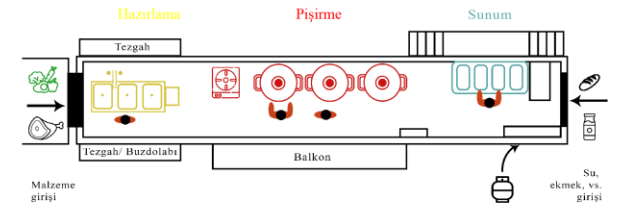
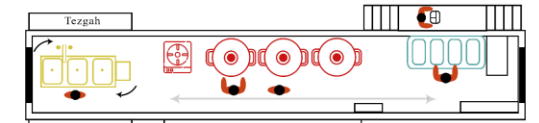

EKİP 4: ELİF YAYLA, FATİH ERTEKİN , HÜSRA ŞAHİN, HAZAL DOĞUKAN, MERVENUR AKASLAN, ORHAN MERT KIRBAŞ, RECEP TEKELİ, YAĞMUR DOĞAN

# 5.1. SAHRA TİPİ BESLENME



TÜRK KIZILAY ÜRÜN TASARIM ÇALIŞTAYI 2019



SAHRA TİPİ BESLENME ÜRETİM SİSTEMLERİ



63m<sup>2</sup> GENEL MAKSAT ÇADIRI

Güncel alanda;

- Sirkülasyon alanı gözetilerek ürün yerleşimi yapıldı.
- Hijyenik ortam oluşturan kolay kurulumu ile zemin stabilizasyonu sağlandı.
- Tezgah ve taşıma birimlerinin depolamada kullanılması ve yemek aktarımı kolaylaştırıldı.
- Çadır içerisinde mevsimsel olarak sıcaklık kontrolü sağlandı ve su buharının tahliye problemlerine çözüm üretildi.

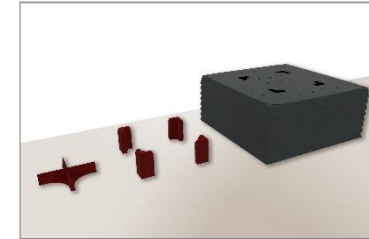

-Zemin birimleri istifli halde alana ulaşır.



-Alana zemin birimleri yerleştirilir.

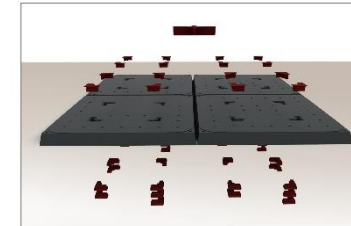

-Takoçlar ve sabitleyiciler yerleştirilir

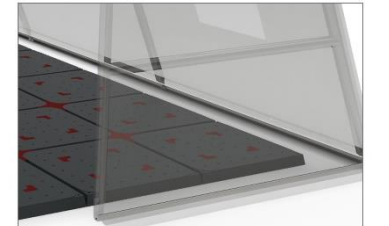

-Yürüme alanı oluşturulur.



# 5.2. İKRAM ARACI



TÜRK KIZILAY ÜRÜN TASARIM ÇALIŞTAYI 2019



İKRAM ARACI



EKİP 5 /A : AHMET GÜREŞÇİ , EZGİ DERİNGÖL , ÖZLEM ÇAĞAN ,ŞİRİN GAMSIZ

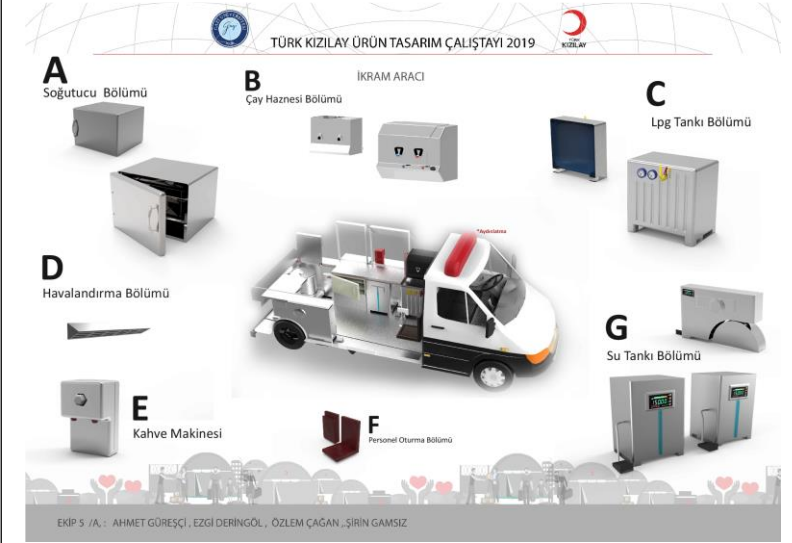

# 6.1. AFET HABERLEŞME ARACI



TÜRK KIZILAY ÜRÜN TASARIM ÇALIŞTAYI 2019



## KABIN SİSTEMİ

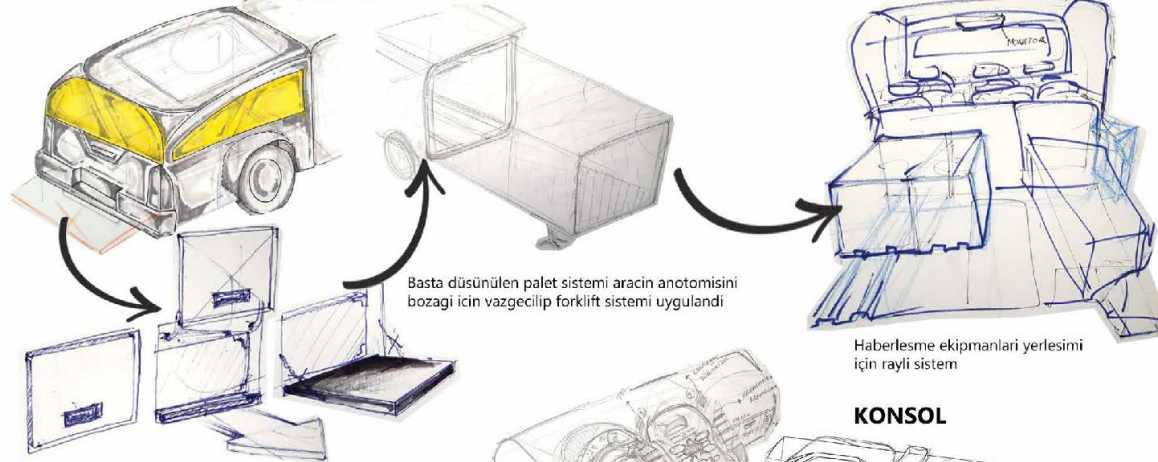

## ARAC İÇİ DEPOLAMA

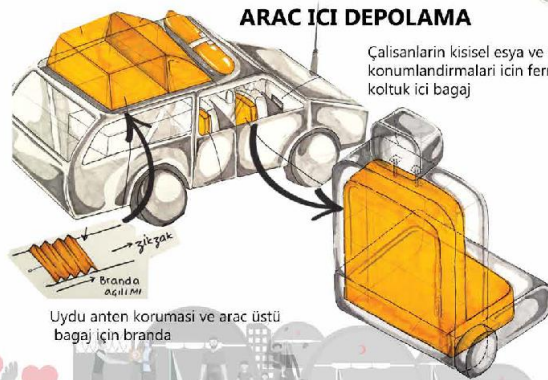

## KONSOL

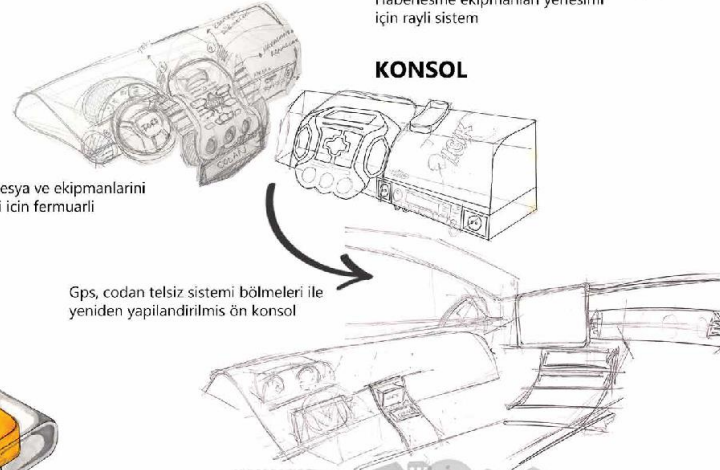

EKİP 6/B: RAHİME GEL, DURU KÖŞGER, RECEP KADİR KIYAK, UMUTCAN ÖNCÜ, ZEYNEP KORKMAZ



TÜRK KIZILAY ÜRÜN TASARIM ÇALIŞTAYI 2019



## KONSOL

Araç konsoluna projeksiyonlu GPS navigasyon eklendi. Telsiz sistemleri ve tepe lambası kumandası için belirli alan oluşturuldu. Konsol yeniden işlevsel ve ergonomik şekilde dizayn edildi.



EKİP 6/B: RAHİME GEL, DURU KÖŞGER, RECEP KADİR KIYAK, UMUTCAN ÖNCÜ, ZEYNEP KORKMAZ



TÜRK KIZILAY ÜRÜN TASARIM ÇALIŞTAYI 2019



## TELESKOPİK MAST

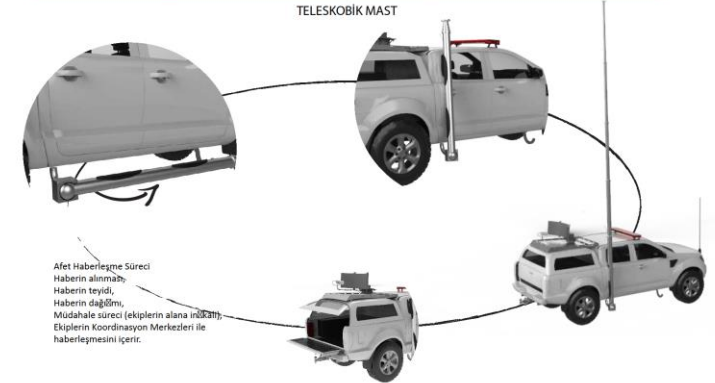

EKİP 6/B: RAHİME GEL, DURU KÖŞGER, RECEP KADİR KIYAK, UMUTCAN ÖNCÜ, ZEYNEP KORKMAZ



# 6.2. AFET MÜDAHALE ARACI



TÜRK KIZILAY ÜRÜN TASARIM ÇALIŞTAYI 2019



AFET MÜDAHALE ARACI / ÖNCÜ ARAÇ

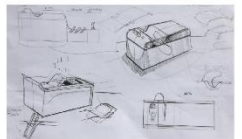
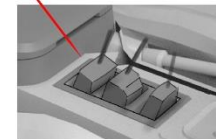
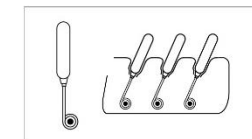
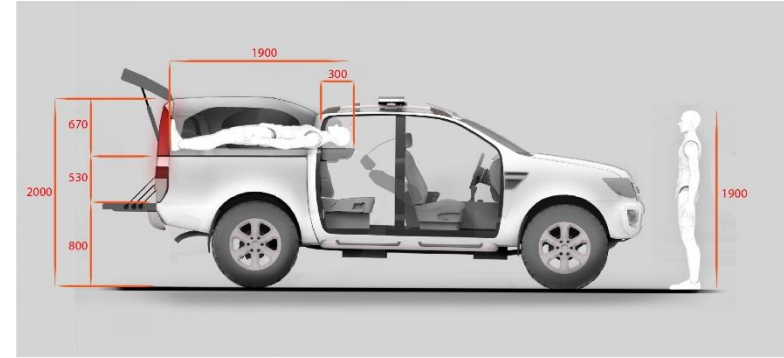
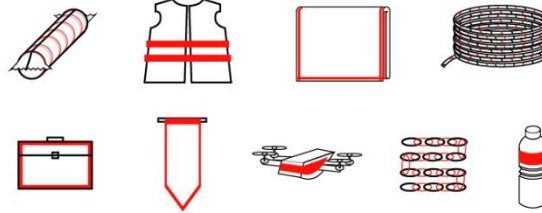
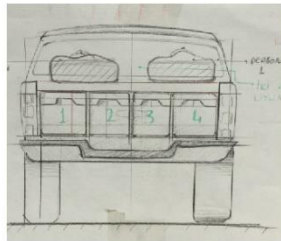
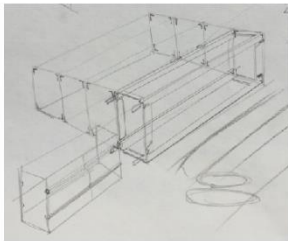
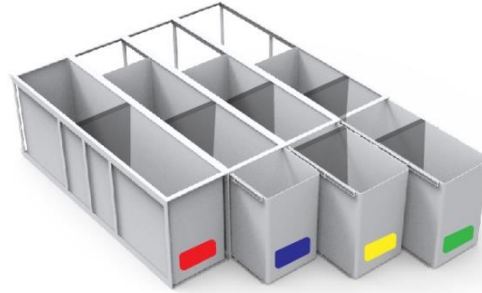



# 7.1. GIDA RASYOSU



GIDA RASYOSU

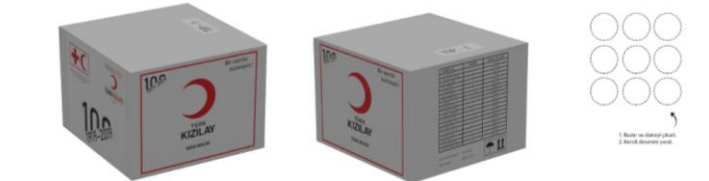
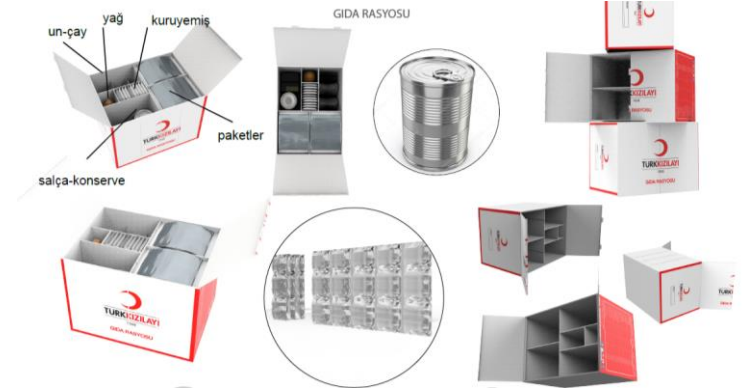
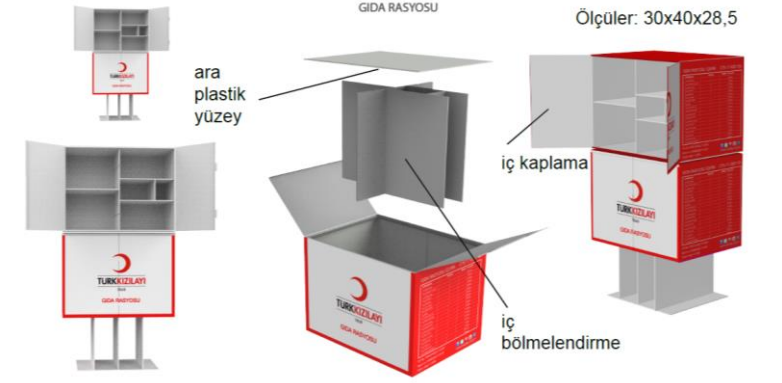

# 7.2. HİJYEN KİTİ



TÜRK KIZILAY ÜRÜN TASARIM ÇALIŞTAYI 2019



HİJYEN KİTİ

HİJYEN KOLISI / BEBEK HİJYEN KOLISI / KİŞİSEL HİJYEN KİTİ

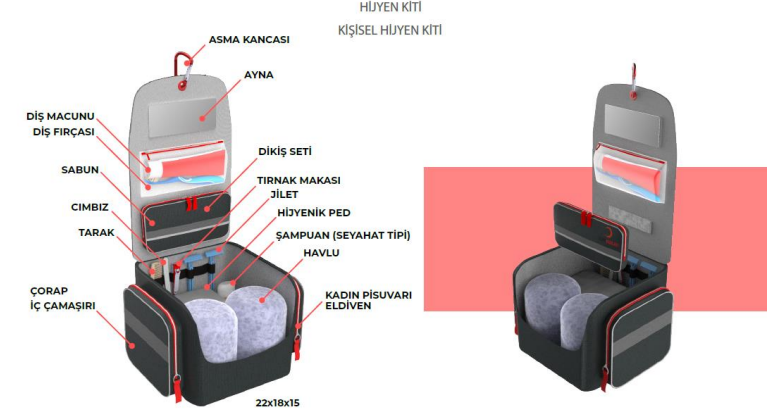

EKİP 7/B: BAŞAK AĞÇA, CEMRE AYÇA AYMELEK, EDA KARA, GAMZE SEVİMLİ

# 8.1. SU SANİTASYON CİHAZI



TÜRK KIZILAY ÜRÜN TASARIM ÇALIŞTAYI 2019



## SU SANİTASYON CİHAZI

Dakikada 1000 ml su arıtabilme  
Toplamda 2000 litre arıtma kapasitesi

**Brief:**  
Dakikada 400 ml su arıtabilme  
Toplamda 1000 litre arıtma kapasitesi



### The MiniWorks™ Ceramic Water Filter.

**Block  
Carbon Core**

- Removes many chemicals, including pesticides, odors and chlorine.
- Improves taste of water.
- Removes odors.

**"Stay Dry"  
Relief Valve**

- Allows excess, non-pressurized water back out stable base.
- Won't open or leak untreated water.

**Filter  
Maintainable**

- Easy disassembly lets you clean/inspect and maintain in the field.

**Adapter  
Base**

- Fits an ACE Hardware™ "Big or Regular" water bottle for convenient two-hand operation.

**Ceramic  
Gauge**

- Measures thickness of the ceramic element as you know when to replace it.

**New  
Marathon™  
206  
Ceramic  
Element**

- Effectively removes bacteria and protozoa including Giardia and Cryptosporidia.
- Inexpensive to use.
- Easy to clean.
- Long lasting.
- 100% tested.

**Fast and  
Easy To Use**

- Easy to pump and use requiring this "dick style" pump.
- Quickly fill your water container, just 90 seconds per liter.

**Tough  
Polyurethane  
Housing**

- Tough, durable and more resistant to fatigue, low temperature damage, and chemicals than polycarbonate.

**Clean-Side  
Cover**

- Protects entire bottom of filter to keep outlet free from contaminants.

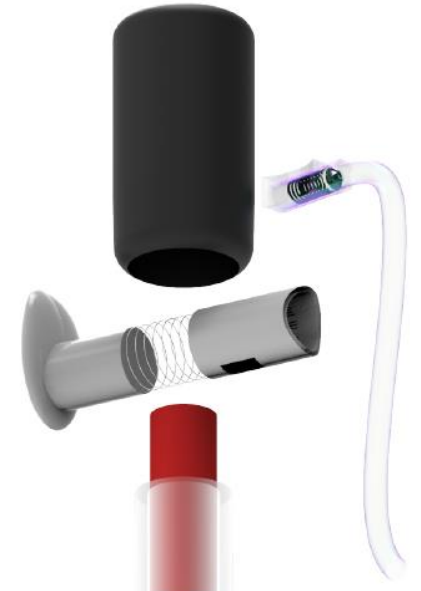



# 8.2. HAYAT İDAME KİTİ



TÜRK KIZILAY ÜRÜN TASARIM ÇALIŞTAYI 2019



HAYAT İDAME KİTİ

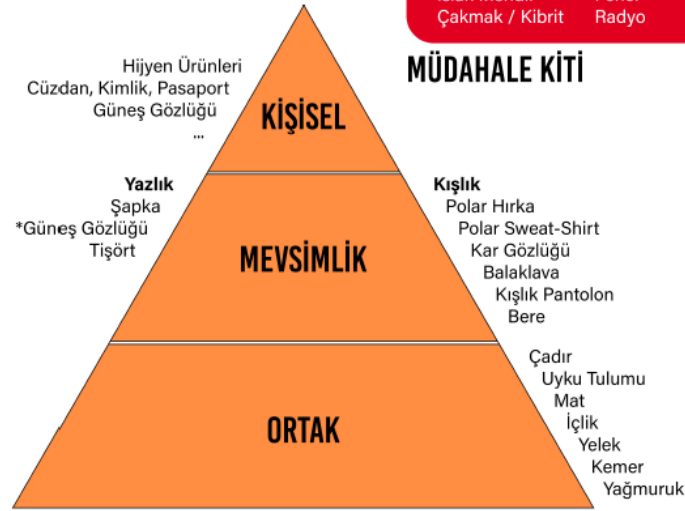
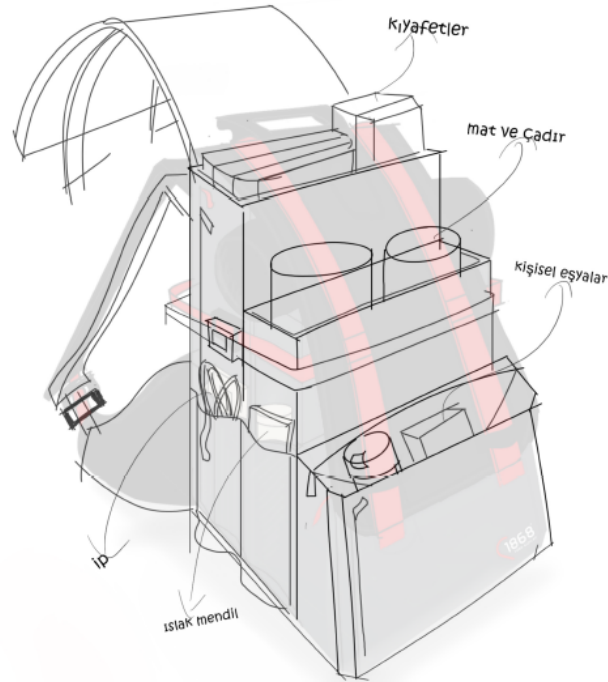

- İlk Yardım Kiti
- Tepe Lambası
- Pusula
- Maske
- Çalışma Eldiveni
- Islak Mendil
- Çakmak / Kibrit
- Dezenfektan
- İsviçre Çakısı
- Alüminyum
- Battaniye
- Düdük
- Fener
- Radyo

## MÜDAHALE KİTİ

- Kışlık
- Polar Hırka
- Polar Sweat-Shirt
- Kar Gözlüğü
- Balaklava
- Kışlık Pantolon
- Bere

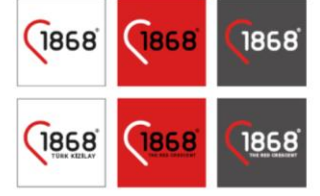

EKİP 8: ELİFNUR ÇELİK, ERVA NURÇİN ŞENAY, MELİSSA TURAN, MUSTAFA GÖKBERK TEKTEK, NESLİHAN AKBAŞ, SENA İLHAN, ZEHRA GÜLMEZ

# 9.1. BAĞIŞ KUMBARASI



TÜRK KIZILAY ÜRÜN TASARIM ÇALIŞTAYI 2019



## BAĞIŞ KUMBARASI

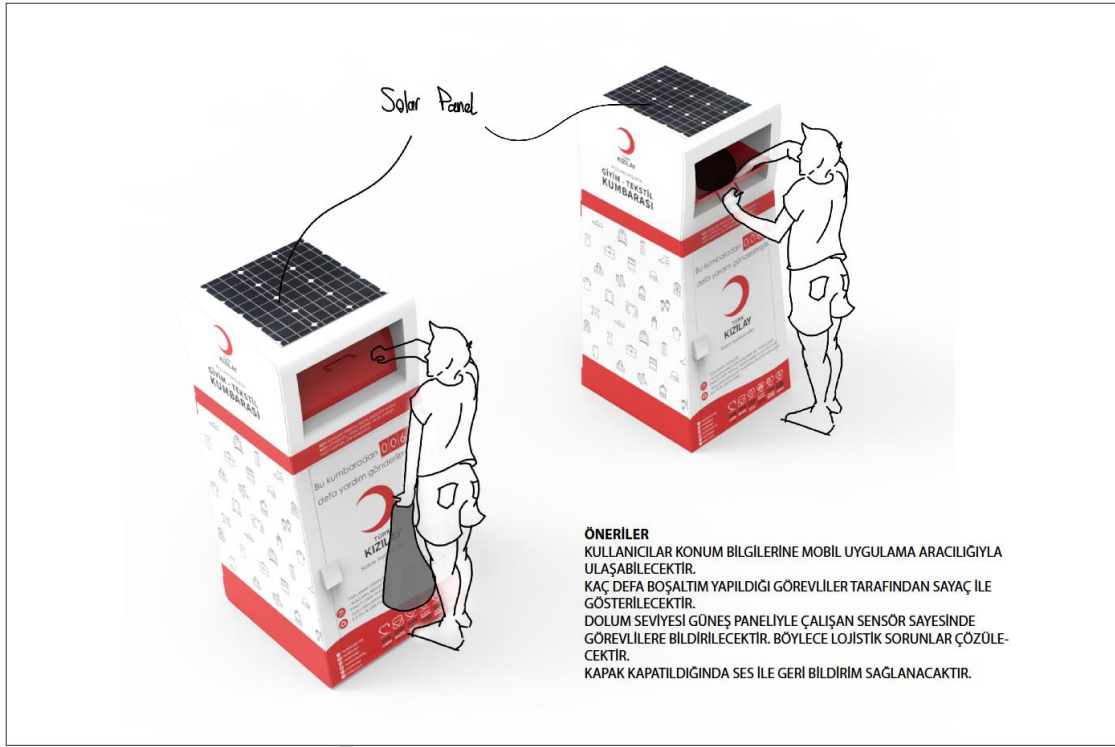

TÜRK KIZILAY ÜRÜN TASARIM ÇALIŞTAYI 2019



BAĞIŞ KUMBARASI

### MEVCUT PROBLEMLER

Kapağın fazla güç gerektirmesi  
Doluluk oranının görevlilere bildirilememesi  
Kutuya atılanların -ikinci el olarak kullanımı dışında- geri dönüşümü yapıldığının yeterince bilinmemesi  
Kullanıcıların süreç hakkında bilgi sahibi olmaması

### Önerilen bilgilendirme:

Toplanan ürünler:

- Kullanılabilir durumda ise temizlenip, paketlenip ihtiyaç sahiplerine ulaştırılıyor.
- Kullanılmayacak durumda ise geri dönüşüm ile iplik üretiliyor.



EKİP 9: ENİS İNAL, FEYZA DEMİRHAN, FATİH EŞREM, BETÜL ARIKAN, YUNUS EMRE DEMİRCİ, BURAK ARAS

# 9.2. SODA ŞİŞESİ



TÜRK KIZILAY ÜRÜN TASARIM ÇALIŞTAYI 2019



MİNERALLI SU ŞİŞELERİ

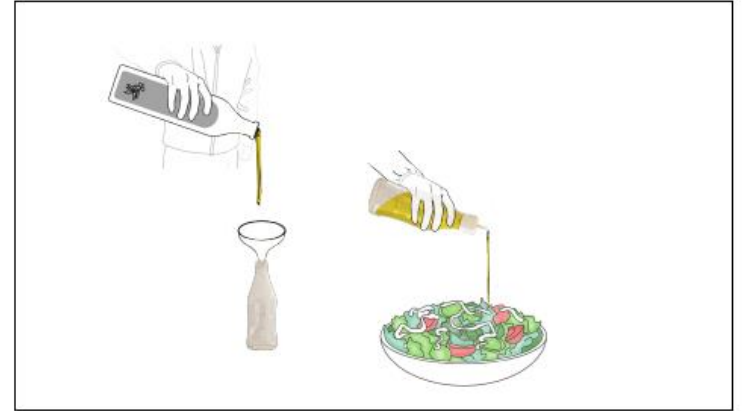
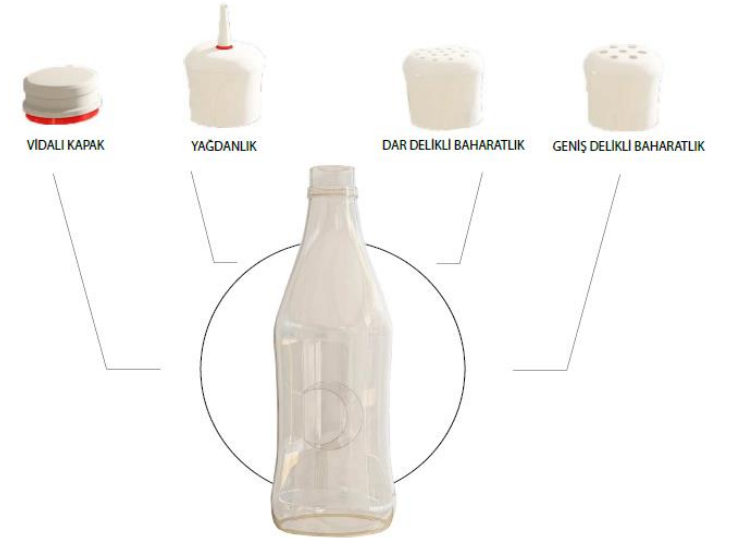



# 10.1. AYNİ YARDIM KOLİSİ



TÜRK KIZILAY ÜRÜN TASARIM ÇALIŞTAYI 2019



## AYNİ YARDIM KOLİLERİ VE AMBALAJ TASARIMI

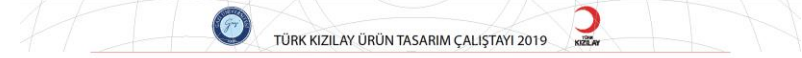
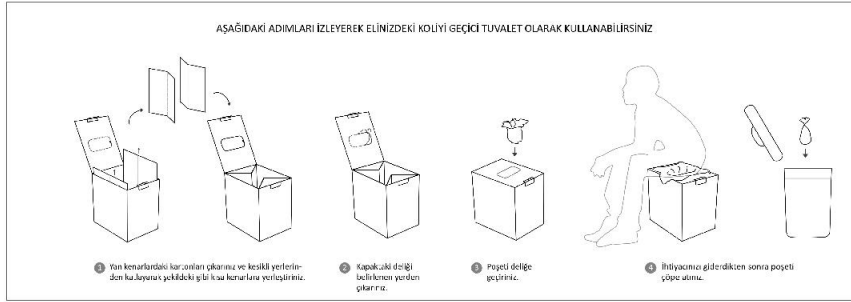

## AYNİ YARDIM KOLİLERİ VE AMBALAJ TASARIMI

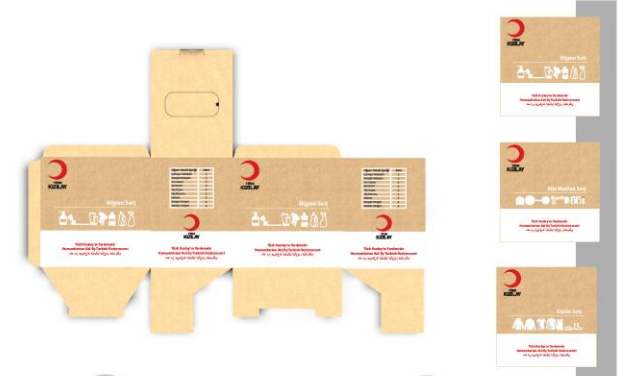

EKİP 10/A: AYÇA KELEŞİYLMAZ, ÇİSEM ERCÖMERT, HANİFE TÜRKSAVAR, HİLAL ERDEM, GAYE POÇAN, PINAR KARAERLER, SERAP ÇELİKKOL

EKİP 10/A: AYÇA KELEŞİYLMAZ, ÇİSEM ERCÖMERT, HANİFE TÜRKSAVAR, HİLAL ERDEM, GAYE POÇAN, PINAR KARAERLER, SERAP ÇELİKKOL

# 10.2. SEVGİ BOHÇASI

KAZANIM ÖDÜLÜ  
TÜRK KIZILAY ÜRÜN TASARIM ÇALIŞTAYI 2019  
TÜRK KIZILAY

SEVGİ BOHÇASI



SEVGİ BOHÇASI



Yeni doğan bir bebek ve annesinin ihtiyaçlarını bir bohçaya doldurduk.

EKİP 10/B ŞULE NUR ZIKNARİNGİL , BEYZA KAÇMAZ , KEREM AYDIN ,DAMLA ÖZER



KAZANIM ÖDÜLÜ  
TÜRK KIZILAY ÜRÜN TASARIM ÇALIŞTAYI 2019  
TÜRK KIZILAY

SEVGİ BOHÇASI

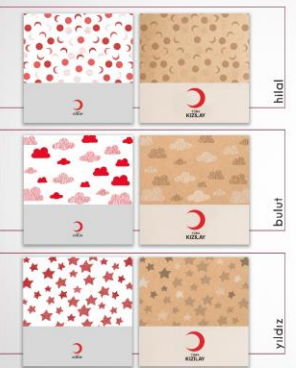

İhlal

bulur

yıldız

askı sayesinde kundak anakucağına dönüştürülür

bebek içeri yerleştirildikten sonra çıkartlar sayesinde kundaklama işlemi bitirilir

ipler büzülerek bebek için kavrama alanı oluşturulur

askı ucundaki karabinalar bu çengellere takılır



EKİP 10/B ŞULE NUR ZIKNARİNGİL , BEYZA KAÇMAZ , KEREM AYDIN ,DAMLA ÖZER